

UHT 58 - door

1

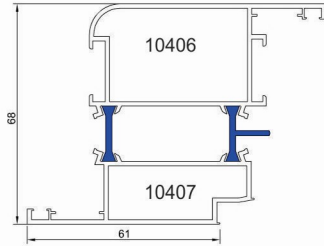

لنگه درب

Door vent profile
 Code : 10406-10407
 weight : 1.8 kg/m

2

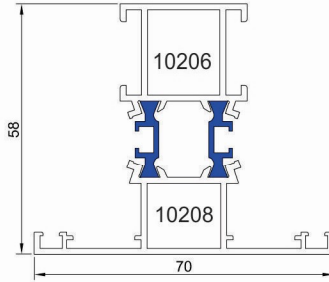

پروفیل سپری

T profile
 Code : 10206-10208
 weight : 1.33 kg/m

3

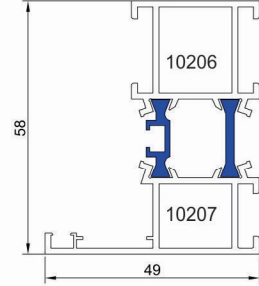

پروفیل فریم

Frame profile
 Code : 10206-10207
 weight : 1.2 kg/m

4

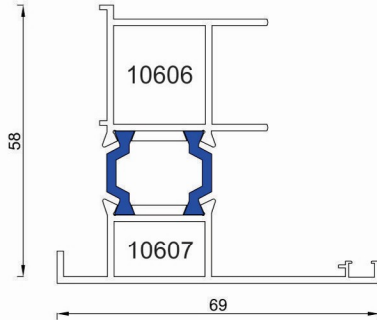

پروفیل واسط ۲ لنگه

The middle of two vent
 Code : 10606-10607
 weight : 1.12 kg/m

5

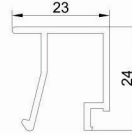

زهوار ۲ جداره ترمال

Double rickety
 Code : 21351
 weight : 0.3 kg/m

6

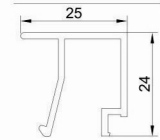

زهوار ۲ جداره ترمال

Double rickety
 Code : 21352
 weight : 0.31 kg/m

7

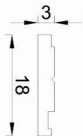

تسمه

Strap profile
 Code : 21361
 weight : 0.14 kg/m

8

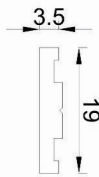

تسمه

Strap profile
 Code : 21362
 weight : 0.15 kg/m

9

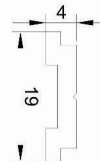

تسمه

Strap profile
 Code : 21363
 weight : 0.17 kg/m

10

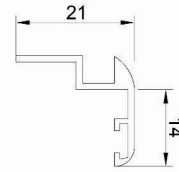

روکوب ۱۴

Suppressed the binding
 Code : 10021
 weight : 0.2 kg/m

UHT 58 - door

11

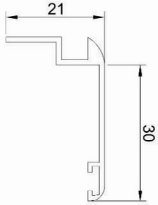

روکوب ۳۰

Suppressed the binding
 Code : 10022
 weight : 0.22 kg/m

12

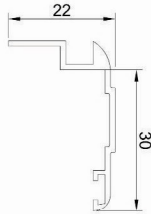

روکوب ۳۰

Suppressed the binding
 Code : 10023
 weight : 0.23 kg/m

13

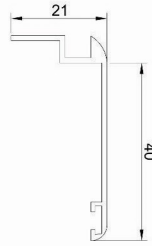

روکوب ۴۰

Suppressed the binding
 Code : 10024
 weight : 0.25 kg/m

14

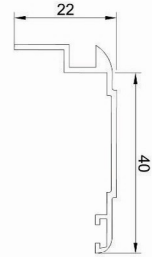

روکوب ۴۰

Suppressed the binding
 Code : 10025
 weight : 0.26 kg/m

15

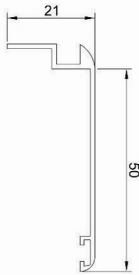

روکوب ۵۰

Suppressed the binding
 Code : 10026
 weight : 0.28 kg/m

16

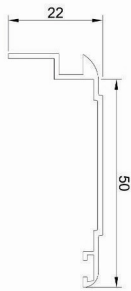

روکوب ۵۰

Suppressed the binding
 Code : 10027
 weight : 0.29 kg/m